

Metode de interogare bazate pe continut a colectiilor de imagini

Sl.dr. ing. Irina MOCANU

Interogarea colectiilor de imagini

- Colectii de imagini cu numar mare de imagini
- Crearea de metode de determinare a similitudinilor dintre imagini
- Descrierea imaginilor pe baza continutului, folosind caracteristici de nivel scazut:
 - Culoare
 - Forma
 - Textura

Interogarea colectiilor de imagini

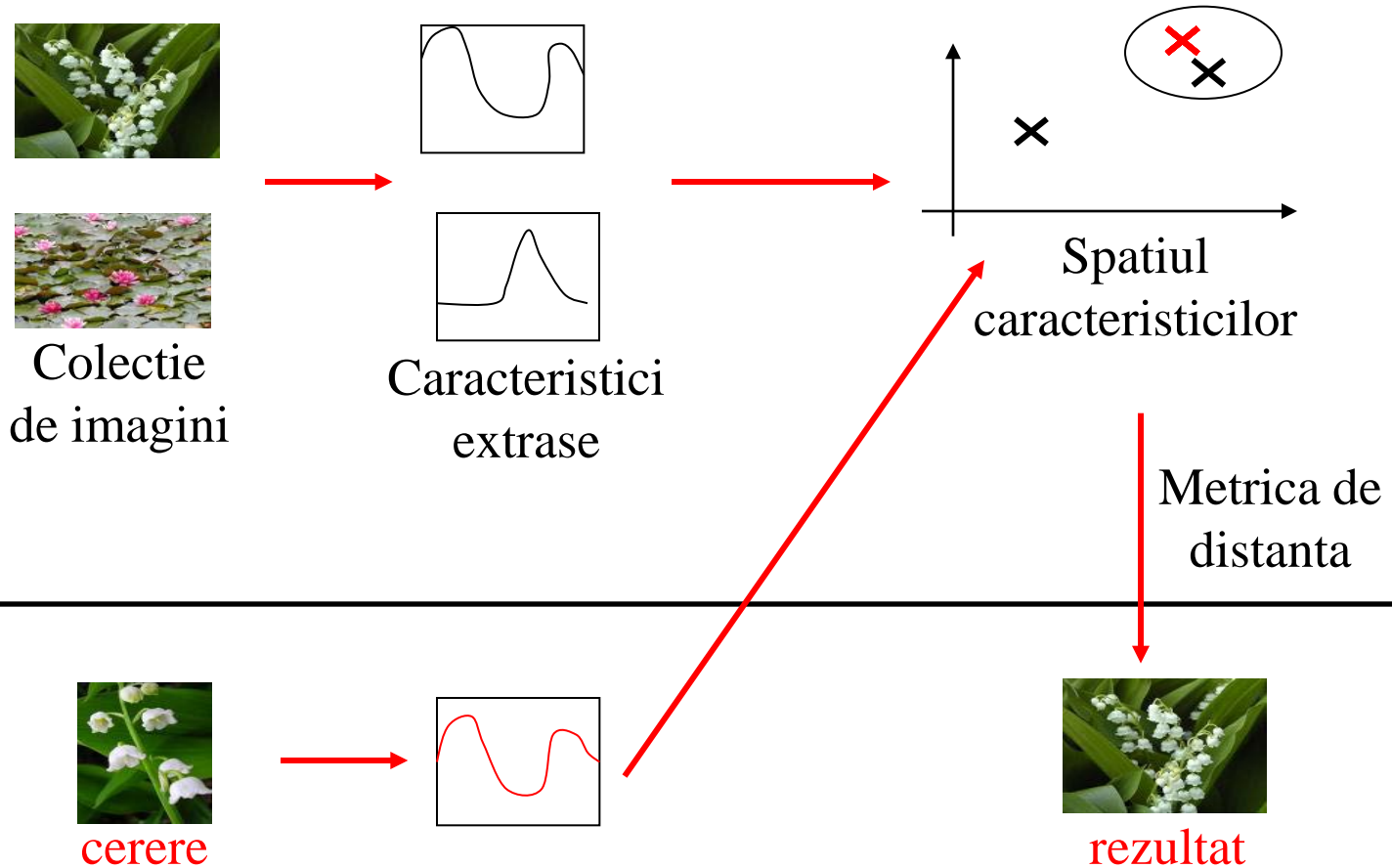

Similitudinea dintre imagini

- Pe baza culorii

imagine 1



imagine 2



Similitudinea dintre imagini

- Pe baza formelor

image 1



image 2



Similitudinea dintre imagini

- Pe baza texturii

imagine 1



imagine 2



Interogarea colectiilor de imagini

Combinarea caracteristicilor de nivel scazut

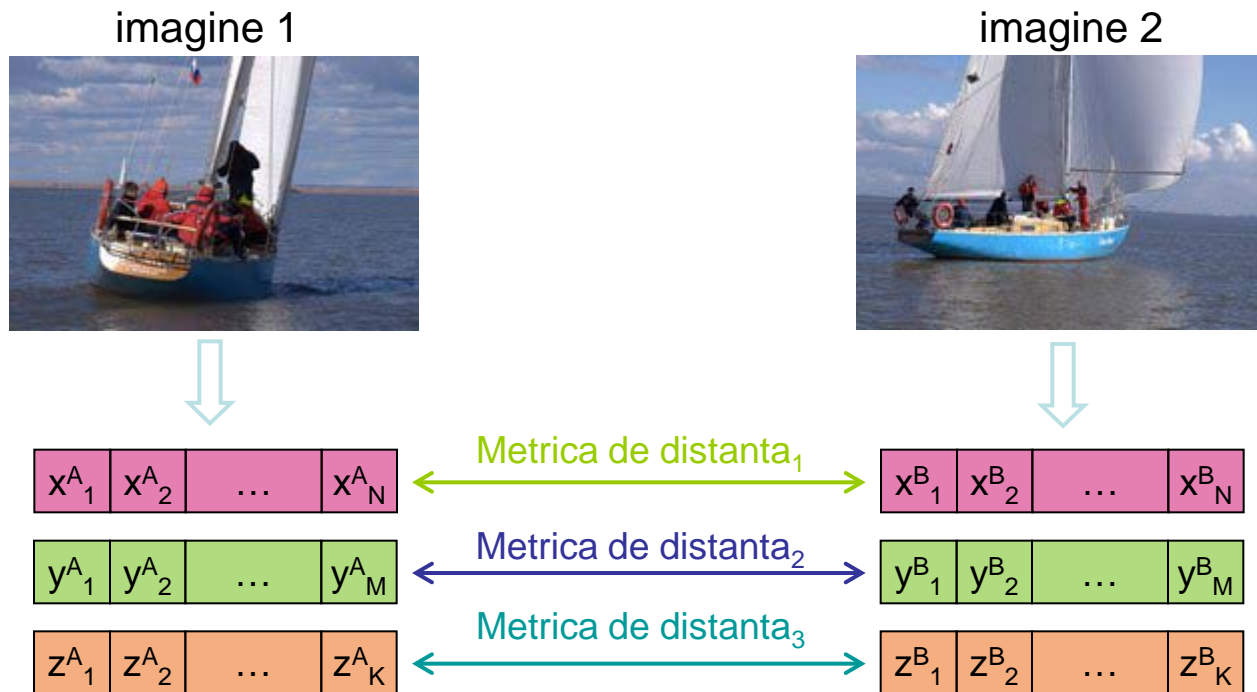

Interogarea colectiilor de imagini

Folosind feedback-ul utilizatorului

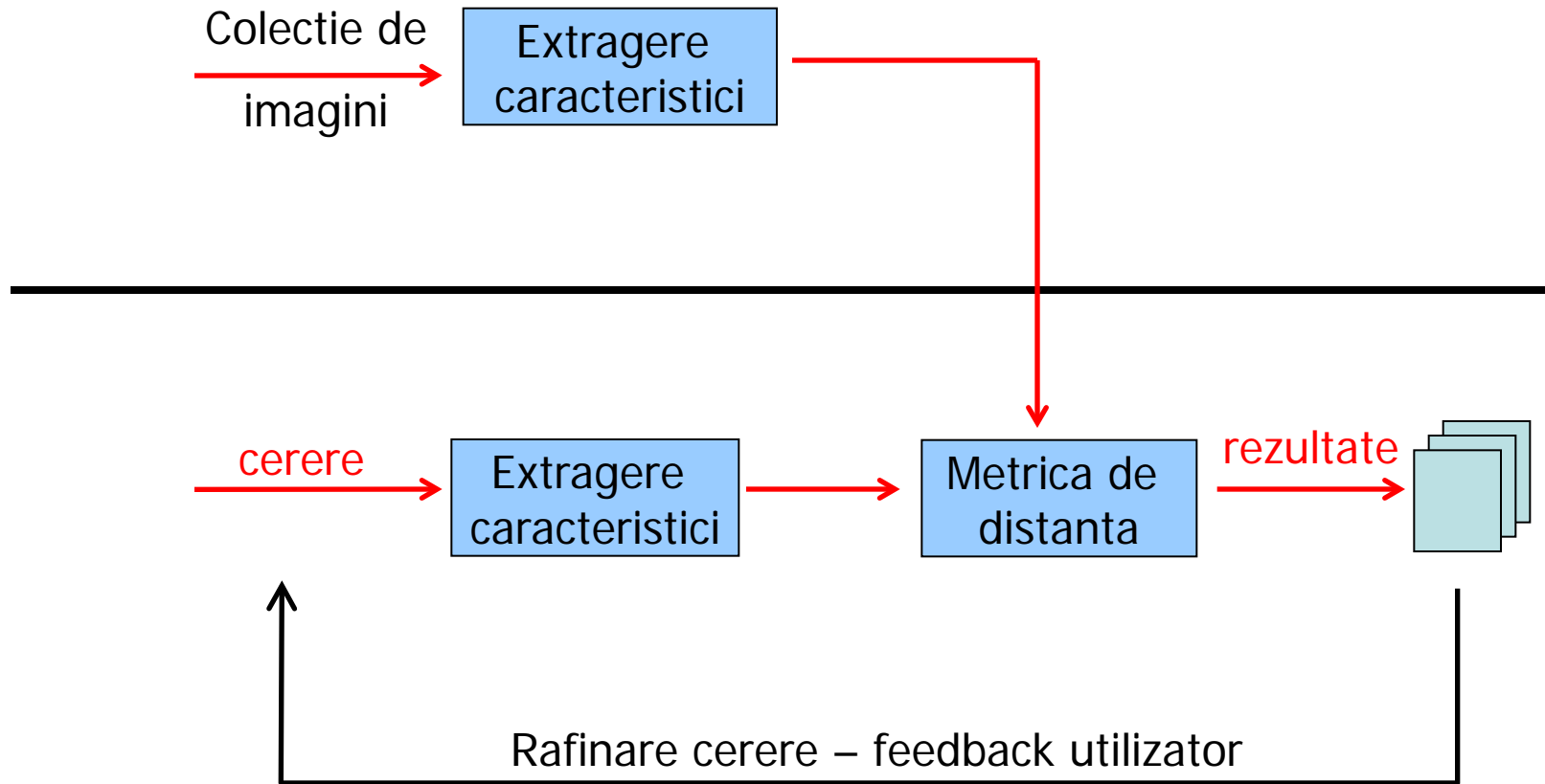

Similitudinea dintre imagini

Pe baza caracteristicilor de nivel scazut:
forma si culoare

Imagine 1



Imagine 2



Similitudinea dintre imagini

Pe baza caracteristicilor de nivel scazut

Imagine 1





Imagine 2



Similitudinea dintre imagini

Pe baza caracteristicilor de nivel scazut

Regasirea imaginilor ce contin "cer"		
albastru	innourat	rasarit
		

Interogarea colectiilor de imagini

Pe baza caracteristicilor de nivel inalt

- Adnotari asociate imaginilor



tigru, iarba

Interogarea colectiilor de imagini

Pe baza caracteristicilor de nivel inalt

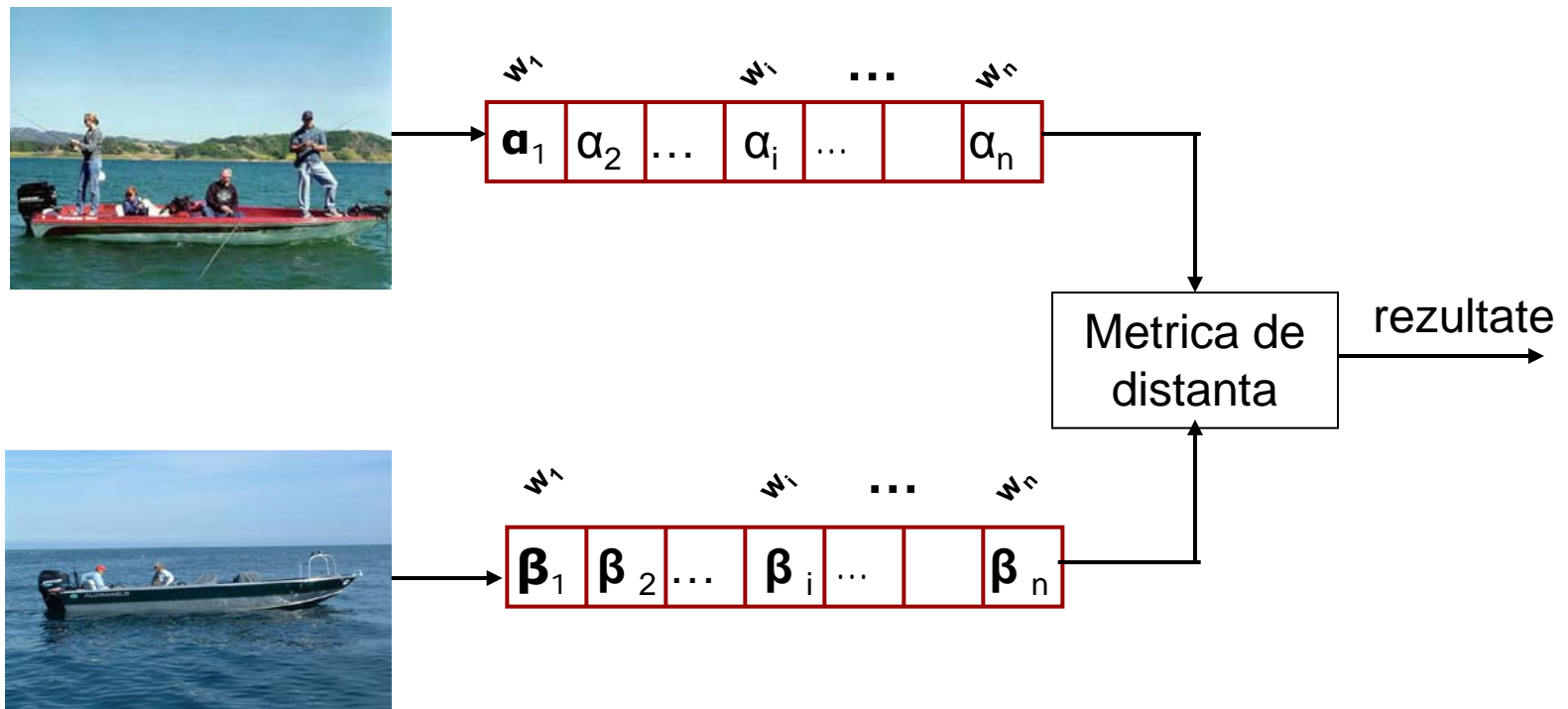

Interogarea colectiilor de imagini

Pe baza caracteristicilor de nivel inalt

animal



caine



Ontologie

Interogarea colectiilor de imagini

- Interogare pe baza caracteristicilor de nivel scazut
- Interogare pe baza caracteristicilor logice
- Interogare pe baza caracteristicilor abstracte